



ANIMAL SCIENCE
TEXAS A&M UNIVERSITY

A photograph of a brown horse with a white blaze on its face, captured in mid-air as if running or jumping in a grassy field. The background shows green trees under a clear blue sky.

Horse Sale

Equine Science Program

May 4, 2013 - 1:30 p.m.

Freeman Arena | College Station, Texas

Introduction



Texas A&M Department of Animal Science's horse program began in 1876, at the inception of Texas A&M University. The horse program has a long history of breeding and raising quality Quarter Horses. Faculty members at Texas A&M were instrumental in organizing and managing the American Quarter Horse Association in 1940. The first foal produced from non-surgical embryo transfer was produced at Texas A&M Animal Science Horse Center.

A full expansion of teaching, research, extension and public service programs in equine science began in the early 1960's, and today the program

involves 5 full-time faculty, 4 staff members, approxi-

mately 20 graduate students and more than 300 undergraduate students.

The TAMU horse program places strong emphasis on equine science and technology, combined with the practical aspects of horsemanship, horse training, showing and judging. This gives a special quality to a program which focuses on the modern horse industry, but one that is built around the basic disciplines of animal science.

This sale features the product of years of selective breeding for athletic performance horses and features some of the most prominent and popular performance bloodlines in the industry today. Many of these horses have been trained and handled extensively by students in basic horse training and advanced stock horse training classes.

It is with great pleasure we have to offer these bloodlines to you today.

Texas A&M University Department of Animal Science faculty and staff: Dr. Martha Vogelsang, Dr. Dennis Sigler, Dr. Josie Coverdale, Dr. Clay Cavinder, Teri Antilley, Dave Golden, Krissy Schroeder, Jennifer Zoller.

Welcome to Aggieland. We hope you enjoy the sale and take a nice horse or two home with you.

Texas A&M University
Department of Animal Science
Horse Sale

Event held at
Texas A&M University
N.W. Dick Freeman Arena
FM 2818
College Station, Texas

May 4, 2013

1:00 p.m. - Viewing/Demonstration of Sale Horses

1:30 p.m. - Horse Sale Begins

Sale Personnel

Sale Managers

Krissy Schroeder,
Assistant Facility Manager
Dave Golden,
Horse Center Facility Manager

Auctioneer

Kevin McMillian
TX license #13317

Auction Clerk

Colleen O'Reilly

Buyer Registration/Checkout

Jacqueline Dusek
Emily Jack

Stall Coordinator

Dave Golden

Ticket Runners

Courtney Grape
Hannah Booth
Shawna Peer

Riders/Handlers

TAMU Graduate
students

Groom

Caitlin Vonderohe

Attending Veterinarian

Mike Martin, DVM

Horse Center Staff

Dave Golden, Horse Center Facility Manager
Krissy Schroeder, Assistant Facility Manager

Andrew Rehkopf
Christopher Moseley
Courtney Grape
Emily Jack
Emma Lichau
Evan Oddo
Hannah Booth
Jacqueline Dusek
Ryan Rhodes
Sarah Keil
Tera Carroll

2013 Graduate Student Breeding Assistants:

Ari Sears
Emma Lichau
Shawna Peer

Terms & Conditions

1. **LAW.** The horses are offered for sale according to the laws of the State of Texas.
2. **BIDDING DISPUTES.** The highest bidder will be the buyer, and if dispute arises between two or more bidders, the horse in dispute shall immediately be put up again for advance bids. If there is no advance, the horse shall go to the person from whom the auctioneer recognized as the last bid. The auctioneer will decline any bid made by parties who have **DEFAULTED** in former purchases, or by persons who, in his judgment are not responsible bidders. Immediately after horse is sold, the buyer shall sign confirmation of purchase and security agreement forthwith. The right to bid is reserved by all sellers.
3. **BUYER'S PAYMENT.** Terms of sale are cash (U.S. funds only) to be paid on the day of the sale. Method of payment shall be Cash, Cashier's Check, Traveler's Checks or pre-approved Personalized Bank Check accompanied by a bank letter of credit. However, all registration papers will be retained by the Sale Management until such checks clear the paying institution. Any payment made by the Buyer to the Consignor or any other party will not be regarded as valid or entitle the Buyer to delivery or title of the horse. All horses must be paid for in this manner regardless of whether they sell in the auction sale ring or on the auction grounds.
4. **GATE RELEASE.** Upon payment by the Buyer to the Sale Cashier, and only the Sale Cashier, the Cashier will issue an order to Buyer which will release the horse from the auction grounds. Buyers are cautioned not to lose this release as it permits holder to pass through the exit gate of the auction grounds with the horse.

Terms & Conditions

5. **LIMITED WARRANTIES.** All responsibilities and guarantees lie solely between Buyer and Consignor. Except as otherwise announced by the auctioneer at time of sale, the Consignor represents and warrants unto Buyer as follows: (1) the horse is free of functional deficiencies with respect to eyes and wind, (2) the horse is not a “cribber” or “wind sucker”, (3) the horse has not been nerved, (4) the sex or condition of a gelding (castrated male horse that is not capable of reproducing), or ridgeling (a colt with undescended testicles) is as described with the definitions provided here, (5) a colt or stallion at least 18 months of age does possess, at time of sale, two testes descended to the scrotum, (6) title to the horse is free from all adverse claims of ownership, use, or possession, and (7) the condition known as Hyperkalemic Periodic Paralysis (HYPP) is as stated or announced at time of sale and no statement or announcement means that the consignor has not disclosed to the sale management whether the horse has been HYPP tested or not, nor the results of such test. Except for the foregoing limited warranties, each horse is sold by the Consignor without warranty and as is, with all faults. Every horse will be sold under this rule. There is not guarantee with respect to the physical condition, health, disposition, use or intended use of any horse in this sale other than the limited warranties by Consignor as set out above.

6. **TITLE.** Title to and risk of loss passes from Consignor to Buyer upon Buyer’s signature of confirmation of purchase immediately after the horse is struck down by the auctioneer.

7. **CARE OF HORSES.** Effective from the time of purchase, the Buyer assumes all responsibility for the maintenance and proper care of the horse, except for those horses participating in research trials. No inhumane treatment, abuse or neglect of any horse will be permitted while horse is on the auction grounds.

Terms & Conditions

8. **RISK OF LOSS.** Risk of loss passes from Consignor to Buyer upon Buyer's signature of confirmation of purchase immediately after the horse is struck down by the auctioneer. This shall especially be the condition in the case of illness, injury, or death of any horse after it has been sold. The Buyer agrees to indemnify and hold the Consignor harmless from all loss, cost, and expense arising from illness, injury, or death of a horse. The loss or damage to property, and the injury or death of persons caused by the Buyer, the Buyer's agents or employees, or by the horse after the horse has been purchased shall be the sole responsibility of the Buyer.

9. **REMOVAL OF HORSES.** All horses, except designated research horses, must be removed from the property either at the conclusion of the sale, or by the evening of the following day, Sunday, May 5th at no additional charge. If an extension is needed, please talk to the sales staff about boarding fees and arrangements.

10. **CATALOG ERRORS.** Every effort has been made to assure correctness of the sale catalog. However, the sale management, auctioneers, and announcers are not responsible for errors or omissions, and assume no liability on its part or on the part of Consignors as to any statements made by the Consignor which are printed in the catalog on behalf of the Consignor. When errors or omissions are brought to the attention of the sale management, auctioneers, or announcers, or when such errors or omissions are discovered by the sale management, announcements will be made to correct such errors or omissions. Buyers are cautioned to pay close attention to these announcements made by the auctioneer or announcer at time of sale as these announcements will take precedence over the printed matter in the sale catalog.

Terms & Conditions

11. **BROODMARES.** All broodmares represented by the Consignor to be in foal will be sold with a veterinary certificate guaranteeing that the mare is in foal. Removal of the mare from the grounds constitutes acceptance of the mare and the Buyer accepts the mare as is. Unless otherwise announced at time of sale, any return privileges or any other agreements, written or otherwise expressed, that exist between the Owner of the covering stallion and the Consignor will terminate at time of sale and not transfer to the Buyer. This shall especially be the condition with respect to, but not limited to, any live foal guarantees, abortion of the foal in utero either by natural causes or otherwise, or refund of any stallion service fees, mare care fees, chute fees, or veterinarian fees.

12. **REGISTRATION CERTIFICATES AND TRANSFER.** All registration certificates and transfer reports will be held by sale management for a minimum of fifteen (15) banking days from the date of sale, or until Buyer's check clears the drawee bank and becomes unconditional credit, whichever is later. Registration certificates and transfers will then be sent to the appropriate breed registry for recording the transfer of ownership into the Buyer's name. Buyer will receive the Registration Certificate from the breed registry. Consignor will be responsible for the transfer fee. Buyer is responsible for any membership fees required by breed association.

13. **CAUTION.** Everyone attending this sale agrees to save and hold harmless and indemnify all Consignors, Texas A&M staff and Sale Management Staff, it's agents, employees or servants, from and against any and all liability, debt, claims, suits, losses, damages, causes of action, judgments, costs and expenses, including attorneys' fees, arising or allegedly arising for personal injury or death of any person or horse, including but not limited to employees of the Consignor or Buyer, property damage, including

Terms & Conditions

loss of use thereof, economical loss or otherwise, arising or growing out of the use of any of Texas A&M University's facilities due in any manner to the negligence or intentional acts of the Buyer or Spectator, any of their employees, agents, or servants in the performance of any act, error, omission, or negligence of the Sale Management Staff occurring concurrently with that of the Consignor, Buyer, or Spectator contributing to any loss indemnified hereunder, except for the sole negligence of willful misconduct of the Sale Management Staff.

14. INSPECTION OF HORSES. All prospective buyers are cautioned and hereby instructed to examine horses thoroughly before purchasing. Buyers should refer to the LIMITED WARRANTIES condition printed above and read the LIMITED WARRANTIES condition in its entirety. It will be strictly enforced.

15. HEALTH REQUIREMENTS. All horses selling in this sale have met the health requirements for the State of Texas, have been required to have been Coggins Tested negative for Equine Infectious Anemia within one (1) year of the sale.

16. CHECK LIABILITY. Any person signing a personalized check will be held liable for the amount of the check. Acceptable form of personal identification will be required. No post dated checks will be accepted. Uncollectible checks will be turned over to the District Attorney for the County of Brazos and charges will be filed. Appropriate legal services will be obtained in whatever State and County necessary in the United States to secure performance of any check given. These conditions will be enforced to the fullest extent of the law and no exceptions will be made.

Terms & Conditions

17. RESALES. In the event a Buyer defaults on accepting or paying for a horse sold to Buyer, the Sale Management reserves the right to accept the same purchase amount from another person, accept the next highest bid, put the horse up for sale a second time, or retain it for the Consignor as unsold; however, nothing shall prevent the sale management and/or the Consignor from pursuing whatever legal remedy available to compel the Buyer to perform as set out herein. Mistakes made by the auctioneer will also necessitate the resale of a horse.

Reference Sire

Dundee Colonel

AQHA# 3404176 • 1995 Dun Stallion

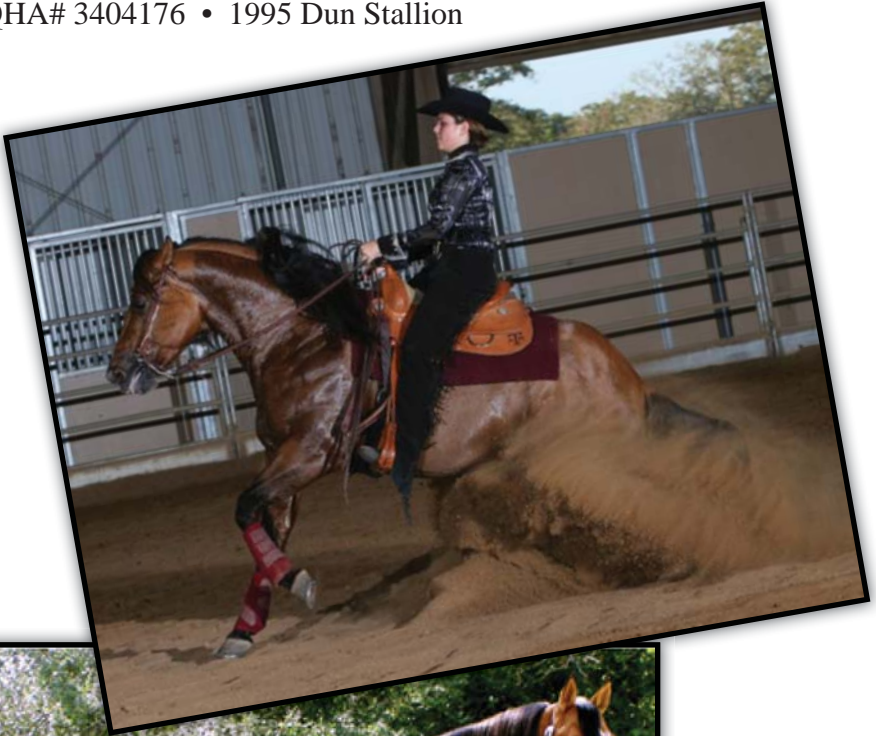

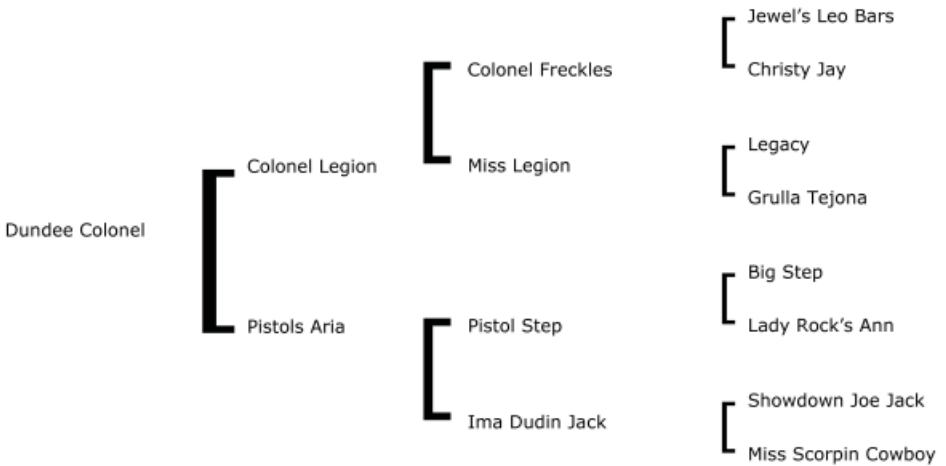

Notes: The breeding and color that sells! By a son of Colonel Freckles and out of a Big Step-bred mare. Dundee has been shown by the TAMU Womens' NCAA Equestrian team and has been ridden by TAMU Stock Horse Team. NRHA Sire and Dam Program.

Sire of 9 Performers earning 2 Performance Wins; 6.5 Performance Points; 2 Novice Wins; Other Earnings: National Reining Horse Association \$353.51; American Buckskin Registry Halter Points 7.0; 23 American Buckskin Registry Performance points.

2013 Breeding Fee: \$500 (includes chute fee)

Reference Sire

TAMU Peppy Rey Jay

AQHA# 3798524 • 1999 Sorrel Stallion



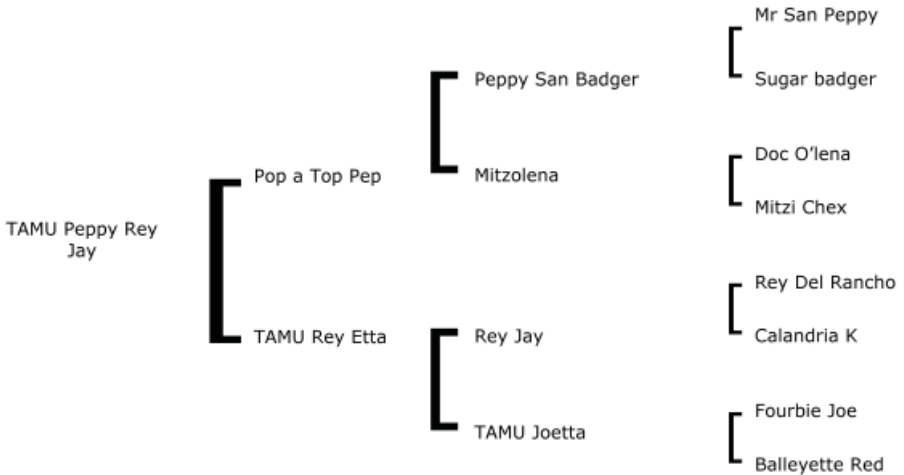

Notes: Great performance pedigree and King Ranch breeding. Shown by TAMU Stock Horse Team. Incentive Fund Nominated.

By Pop a Top Pep. 3rd Place NCHA Futurity. NCHA earnings \$162,466.74.

Pop a Top Pep NCHA offspring earnings \$461,922.12.

Rey Jay: NCHA Non-Pro Finals. AQHA Champion. Performance ROM. 51 Performance Wins; 261.5 Performance Points; 12.0 Halter Points; 1 Performance ROM; Superior Performance Award; AQHA Championship; 3 Reserve Grand Championships. NCHA \$20,597.07. Grandsire of offspring earnings NCHA \$4,057,631.32; NRHA \$92,034.84; NRCHA \$70,165.57.

2013 Breeding Fee: \$500 (includes chute fee)

Reference Sire

Chicoutmyblingbling

AQHA# 4511696 • 2004 Bay Stallion



Owned by Matt Lantz

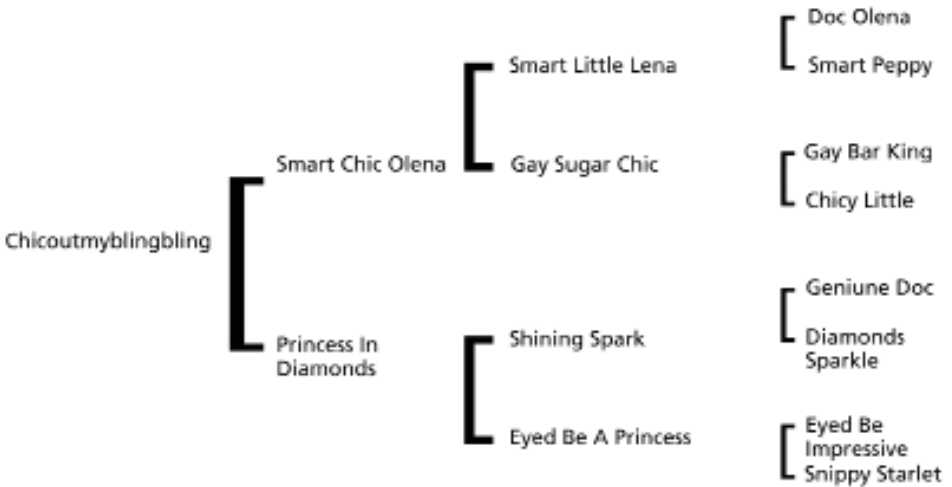

Notes: by SMART CHIC OLENA (AQHA World Senior Cutting & Reining Open Champion; Hall of Fame; NRHA World Champion, Reserve World Champion NRHA Open; NRHA LTE \$13,530, NCHA LTE \$167,471; Herda N/N), out of PRINCESS IN DIAMONDS (NRHA Earnings \$76,976.37 and producer of two NRHA Open Futurity Finalists), by SHINING SPARK.

“Jag” does not have a show record due to an injury sustained in early training. His first foal crop is the 2010 foals. He is producing foals with curious minds, athleticism, and sound conformation!

Reference Sire

Bobby Sox Playboy

AQHA# 3108566 • 1992 Chestnut Stallion



Owned by Covert Ranch

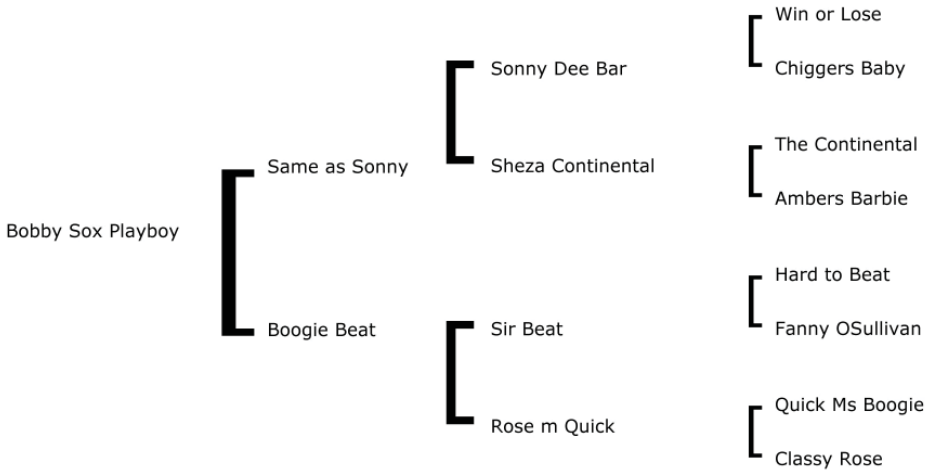

Notes: AQHA Open Superiors in Heading, Heeling & Calf Roping. 745 points in heading, heeling, calf roping, working cow horse, reining, and halter. AQHA Performance Champion

- 2001 AQHA All-Around High Point Stallion and GMC Truck Award Winner
- 2001 AQHA Open High Point Dally Team Roping Heeling Champion
- 2001 AQHA Top-Ten Senior Halter Stallion
- 2001 Denver National Open Heading Champion
- 2001 Southern Arizona QHA Spring Circuit Open Calf Roping Reserve Champion
- 2001 Oklahoma AQHA Spring Show Circuit Open Heeling Champion
- 2001 Colorado Super Circuit Roping All-Around Reserve Champion
- 2001 Oklahoma AQHA Redbud Spectacular Senior Calf Roping Champion
- 2001 Tulsa Holiday Summer Circuit Senior Heading Champion
- 2001 Quarter Horse Association of Nebraska All-Around Reserve Champion
- Nebraska Rope Horse Association-1999 Champion Calf Roping Horse
- FQHA-1999 Champion Heading Horse-1999 Champion Heeling Horse-
- 1999 Reserve Champion Calf Roping Horse

Reference Sire

Sonnys Blondy Dude

AQHA# 3658336 • 1997 Gray Stallion • 1997-2011



*Stallion Deceased
Owned by Covert Ranch*

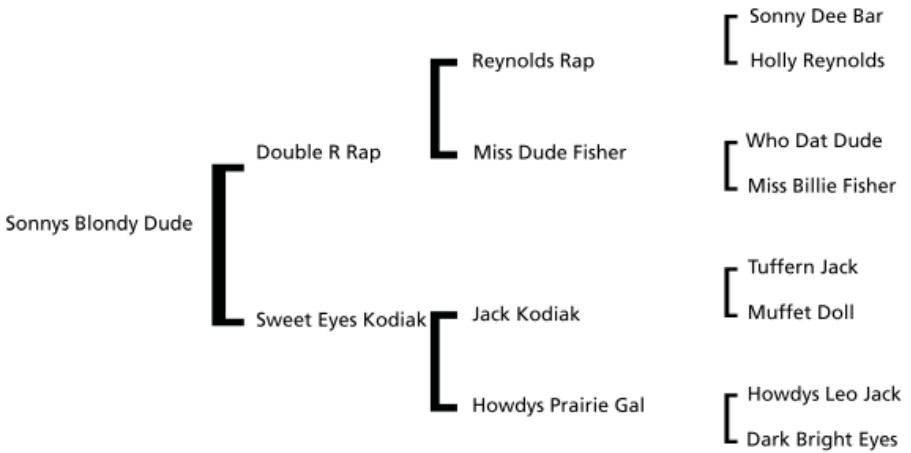

Notes: Superiors in Calf Roping, Heading, and Heeling. AQHA Performance Championship. 441.5 AQHA points. 2003 Senior Open AQHA High Point Calf Roping Champion Stallion. 2001 Top-Ten Calf Roping Horse. ROMs in Heading and Heeling

By Double R Rap: Six-time World Champion Buckskin Horse
1992 AQHA World Show Aged Halter Stallion -7th

Reference Sire

Two Eyed Red Baron

AQHA# 3284762 • 1994 Chestnut Stallion



Owned by Covert Ranch

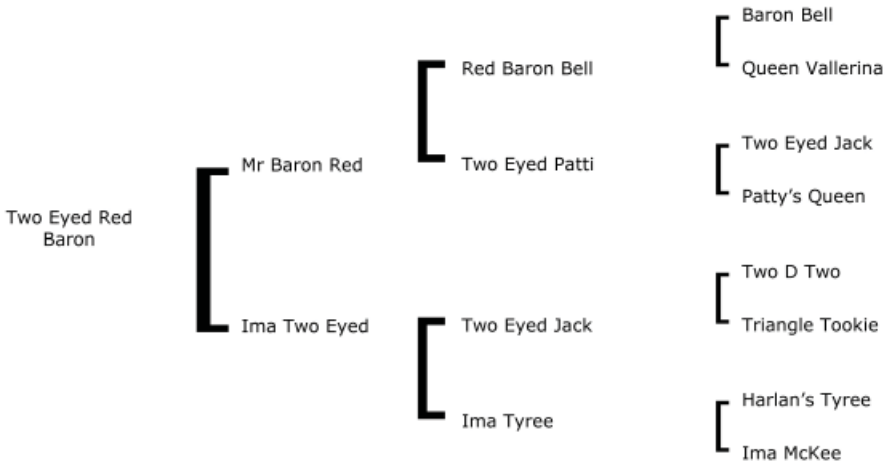

Notes: AQHA Performance Champion, Superior in Heading, Heeling, & Calf Roping and ROM Halter. 547 AQHA Open Points

“Baron” is 91% Foundation bred and 44% Two Eyed Jack, the All-Time Leading Sire of AQHA Champions. His bloodlines also go back to such greats as Joe Reed P-3, Silver King by Old Sorrel, Grey Badger, Joe Hancock, Peter McCue, King P-234, Hard Twist and Cowboy.

By Mr Baron Red: AQHA Champion and 1983 AQHA World Championship Show Super Horse. AQHA Points in reining, cowhorse, halter, calf roping, and heeling.

Out of Ima Two Eyed, an own daughter of Two Eyed Jack, and full sister to AQHA Champion Two Eyed Tyree with Superiors in Halter and Steer Roping.

Reference Sire

Millennium CD

AQHA# 3664285 • 1998 Gray Stallion • 1998-2008





Notes: Color producer and super performance breeding! Half-brother to Some Kinda Memories (NCHA \$378,546) and out of Some Kinda Playgirl (\$88,732).

By CD Olena: NCHA Horse of the Year. NCHA Derby Champion. NCHA Futurity Champion. NCHA earnings \$170,706.42. #5 All-Time Leading Active Sire. Offspring earnings over \$11 million. National Reining Horse Association \$19,300.87; National Reined Cow Horse Association \$204,904.40; United States Team Penning Association \$9,409.69.

2013 Stallion Roster

Texas A&M University

Department of Animal Science Horse Center

TAMU Peppy Rey Jay

- **1999 Sorrel Stallion**
- Pop A Top Pep (Peppy San Badger) x TAMU Rey Etta by Rey Jay
- **2013 Stud fee \$500**
(chute fee included)
- Owned by TAMU Animal Science
- Producer of great all-around horses. Shown by the TAMU Stockhorse Team.

Dundee Colonel

- **1995 Dun Stallion**
- Colonel Legion (Colonel Freckles) x Pistols Aria by Pistol Step
- **2013 Stud fee \$500**
(chute fee included)
- Owned by TAMU Animal Science
- Used by the TAMU Women's Equestrian Team.

Shadownics

- **2001 Bay Stallion**
- Bueno Chexinic (Reminic) x Muskegs Shadow by Muskeg
- **2013 Stud fee \$750**
(chute fee included)
- ROM / Qualifier in Sr. Reining World Show, Select World Shows, & Jr. Reining World Shows
- Owned by TAMU Animal Science
- **NRHA \$30,367.90**



Sonitanovemberlena

- **2001 Chestnut Stallion**
- Sonitalena (Doc O Lena) x November Dove by Haidas Little Pep
- **2013 Stud fee \$750**
(chute fee included)
- Top 10, NCHA Summer Cutting Spectacular Derby Open; finalist in the NCHA Super Stakes Classic/Challenge Open; finalist in the Suncoast Derby Open, Memphis Futurity 4-Year-Old Open and Bonanza Cutting 5/6-Year-Old Open; split 5th, Houston Livestock Show & Rodeo Cutting Open
- Owned by Michael Krueger
- **NCHA \$33,801**

Call for more information & to see the stallions!

Dave Golden, facilities manager, or Krissy Shroeder, assistant facilities manager
503 George Bush Dr, 249 Kleberg Bldg, College Station, TX 77843
(979) 845-4320 | email: horsecenter@tamu.edu | website: horsecenter.tamu.edu

Lot Order

Lot	Name	Age	Color	Gender	Sire	Dam
1	TAMU ChicOurThisBarbie	2010	Palomino	Mare	Chicoutmyblingbling	Laras Acre
2	TAMU Popa Top Boogie	2011	Sorrel	Mare	Bobby Sox Playboy	TAMU Pop A Top Rey
3	TAMU Nu Walkabout	2010	Sorrel	Gelding	Chicoutmyblingbling	TAMU Nu Maurleen
4	TAMU SonnyFancyDun	2011	Gray/Dun	Gelding	Sonnys Blondy Dude	TAMU Ima Fancy Star
5	TAMU Quixote Siren	2007	Sorrel	Mare	Millennium CD	Dandy Ghostbuster
6	TAMU ZippinInFashion	2010	Sorrel	Mare	Mister GQ	Zippin N Dreamin
7	Sandys Dirt Dash	2002	Sorrel	Mare	Dirt In Your Face	Sandy Bars Joesi
8	TAMU Smart Lil Nu Bar	2010	Chestnut	Gelding	Chicoutmyblingbling	TAMU Nu Mascara
9	TAMU Watch Me Shine	2010	Bay	Gelding	Chicoutmyblingbling	Watch Super Suzie
10	TAMU ShinenEnterPriz	2010	Bay	Mare	Chicoutmyblingbling	TAMU Nu Enterprise
11	TAMU Nu Troubadour	2011	Bay	Gelding	Chicoutmyblingbling	TAMU Nu Maurleen
12	Slick Slidin Jag	2011	Brown	Gelding	Chicoutmyblingbling	Hicks Slick Chick
13	Bobby Sox Baroness	2003	Sorrel	Mare	Two Eyed Red Baron	CCC Bobby Sox Jackie
14	TAMU Jack Be Nimble	2011	Sorrel	Gelding	Bobby Sox Playboy	Hi Cotton Candy 104
15	Cds Nu Moves	2008	Gray	Mare	Millennium CD	TAMU IBA Nu Rey
16	TAMU A Jagin Deelux	2011	Sorrel	Gelding	Chicoutmyblingbling	CCC Bobby Sox Deelux
17	TAMU Dixie Darlin	2011	Sorrel	Mare	Two Eyed Red Baron	TAMU Nu Bar Bella
18	TAMU A Nu Bar Baron	2011	Sorrel	Gelding	Two Eyed Red Baron	TAMU Nu Dee Colonel
19	TAMU Jazzy LilClancy	2011	Sorrel	Gelding	Chicoutmyblingbling	Laras Acre

Lot 1

Consignment from Texas A&M University

TAMU ChicOutMyBarbie

AQHA# 5296726 • 2010 Palomino Mare

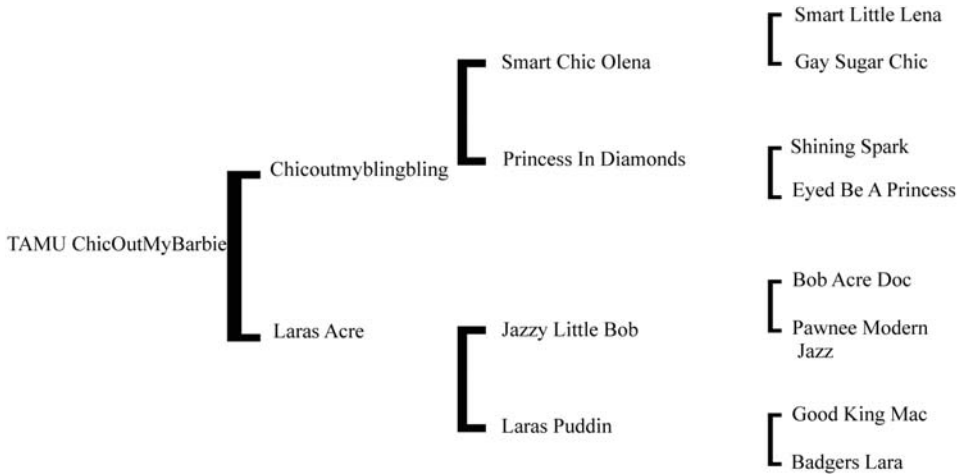

Notes: *Tremendous individual! Beautiful palomino color; cutter / reining prospect. One of two “Jag” fillies to be sold today...don’t miss out! She is enrolled in the National Reining Breeders Classic.*

Sire: CHICOUTMYBLINGBLING (reference sire). By the great SMART CHIC OLENA (AQHA World Senior Cutting & Reining Champion) and out of PRINCES IN DIAMONDS, NRHA (producer of 3 NRHA Open Futurity Finalists, including Wizkey N Diamons and Cromed Out Merceded).

Dam: By JAZZY LITTLE BOB (producer of 18 performers; sire of Jazz It Up Honey, \$18,862 & finalist in the Memphis 4-yr-old Futurity, plus 3 other money earners over \$10,000); Grandsire - BOV ACRE DOC (2 time World Champion Sire of Offspring earnings in excess of \$6.9 million).

Lot 2

Consignment from Texas A&M University

TAMU Pop A Top Boogie

AQHA# 5365695 • 2011 Sorrel Mare

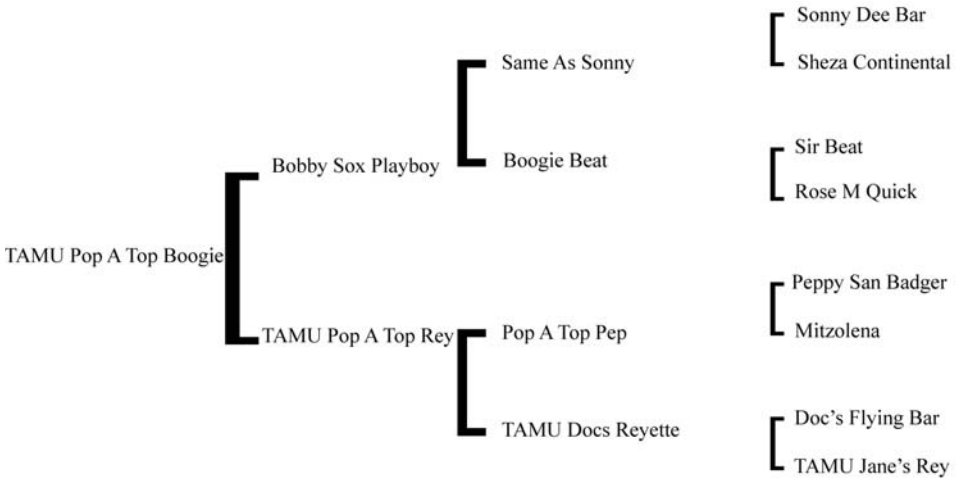

Notes: *Nice mover; bred to be a performance horse. She has a good mind; she speaks for herself!*

Sire: BOBBY SOX PLAYBOY (reference sire). AQHA Performance Champion; 745 AQHA points.

Dam: by POP A TOP PEP (NCHA earnings of \$162,466.74; COA Bronze; sire of Superior Performance, ROM Performance, NCHA money-earners, and Performance Point earners; NCHA offspring earnings \$461,922.12).

Lot 3

Consignment from Texas A&M University

TAMU Nu Walkabout

AQHA# 5309393 • 2010 Sorrel Gelding

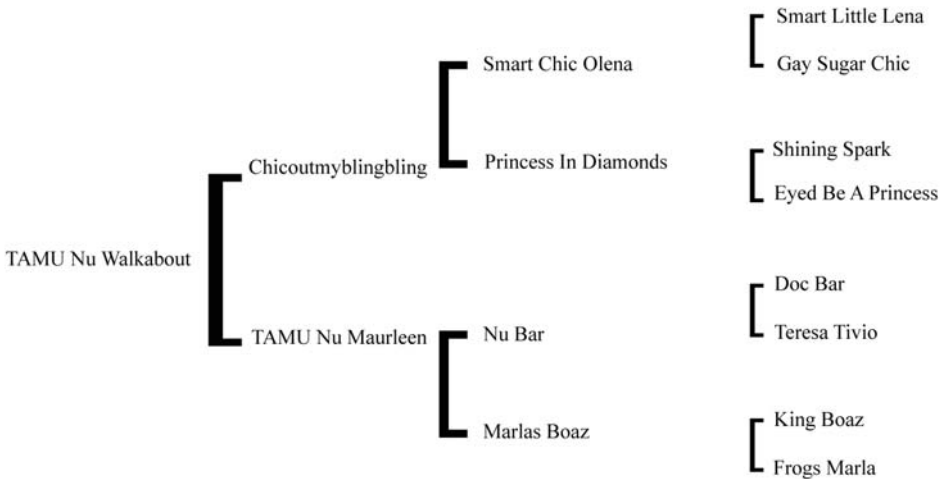

Notes: “Walkabout” is a big, stout horse; a heading horse deluxe!
Enrolled in the National Reining Breeders Classic.

Sire: CHICOUTMYBLINGLING (reference sire). By the great SMART CHIC OLENA (AQHA World Senior Cutting & Reining Champion) and out of PRINCESS IN DIAMONDS, NRHA (producer of 3 NRHA Open Futurity Finalists, including Whizkey N Diamonds and Cromed Out Mercedes).

Dam: by NU BAR (AQHA Reserve World Champion cutting, ROM performance, NCHA Bronze Award, Top Ten World Show. NCHA earnings \$16,539. Sire of NCHA/NRHA money earners; Top Stallion Ranked By All Time Offspring Cutting earnings and All Time Offspring Lifetime Average Cutting earnings. LTE \$895,493. Sire of Superiors in Halter & Performance)

Lot 4

Consignment from Texas A&M University

TAMU Sonnys FancyDun

AQHA# 5451968 • 2011 Gray/Red Dun Gelding

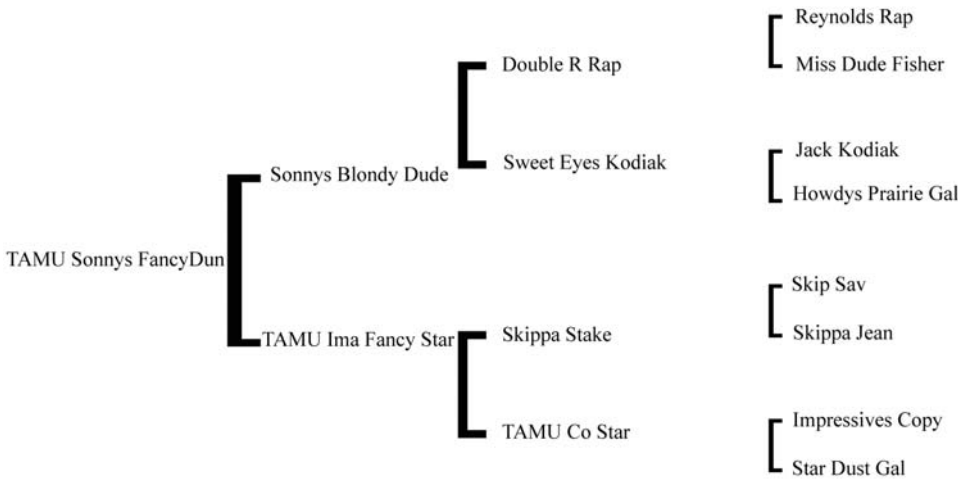

Notes: *Don't miss this colt! Outstanding performance prospect. He's pretty, and would make a great 4-H prospect; a super prospect for the State 4-H Futurity next year.*

Sire: SONNYS BLONDY DUDE (reference sire). AQHA Performance Champion.

Dam: by SKIPPA STAKE (Reserve World Champion halter pedigree).

Lot 5

Consignment from Texas A&M University

TAMU Quixote Siren

AQHA# 4958824 • 2007 Sorrel Mare

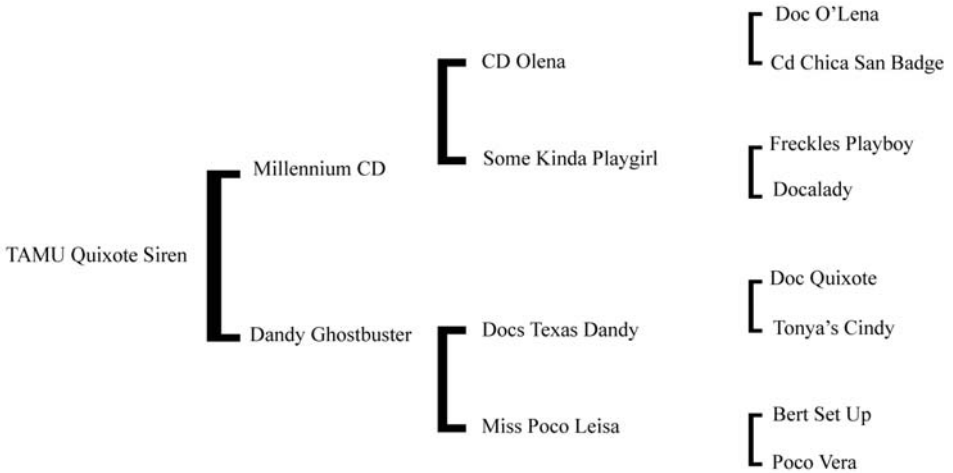

Notes: *Highlight of the sale! Gorgeous mare with a great set of papers. Bred to be put on a cow. One of two fillies being sold by Millennium CD. Sire: MILLENNIUM CD (reference sire). By CD Olena (NCHA Horse of the Year, Derby Champion, & Futurity Champion), out of SOME KINDA PLAYGIRL (NCHA earner of \$88,732).*

Lot 6

Consignment from Dave Golden & Park Phillips

TAMU ZippinInFashion

AQHA# 5360523 • 2010 Sorrel Mare

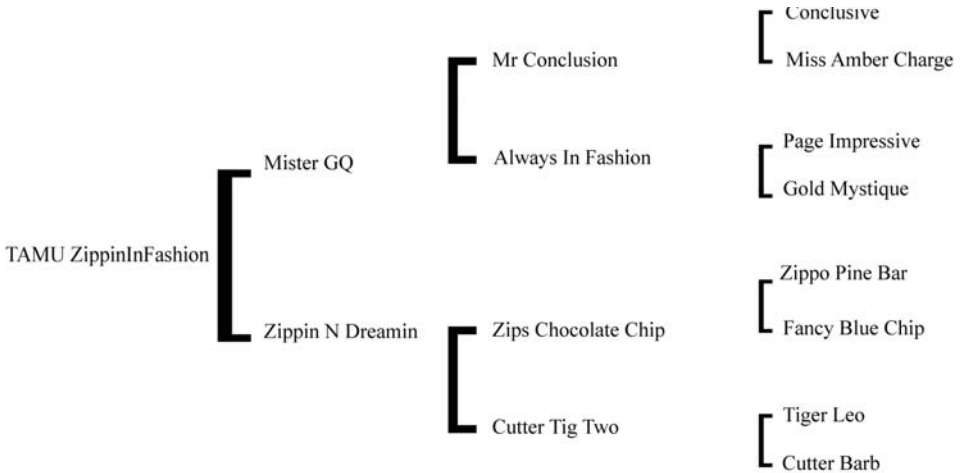

Notes: *By a two-time World Champion halter sire, and out of a daughter of a World Champion. Pretty mover; great youth prospect.*

Sire: MISTER GQ (Two-time World Champion; Two-time Reserve World Champion Halter; ROM Halter; Superior Halter; sire of World Champion offspring, Reserve World Champions, Top 10 World Show offspring, & Superior Halter horses).

Dam: by ZIPS CHOCOLATE CHIP (ROM Western Pleasure, Superior Western Pleasure, 1988 World Top Ten Jr Western Pleasure, 1989 World Champion Western Pleasure, 1999 NSBA Hall Of Fame, AQHA All-time Leading Sire of Western Pleasure Horses).

Lot 7

Consignment from Texas A&M University

Sandys Dirt Dash

AQHA# 4272090 • 2002 Chestnut Mare

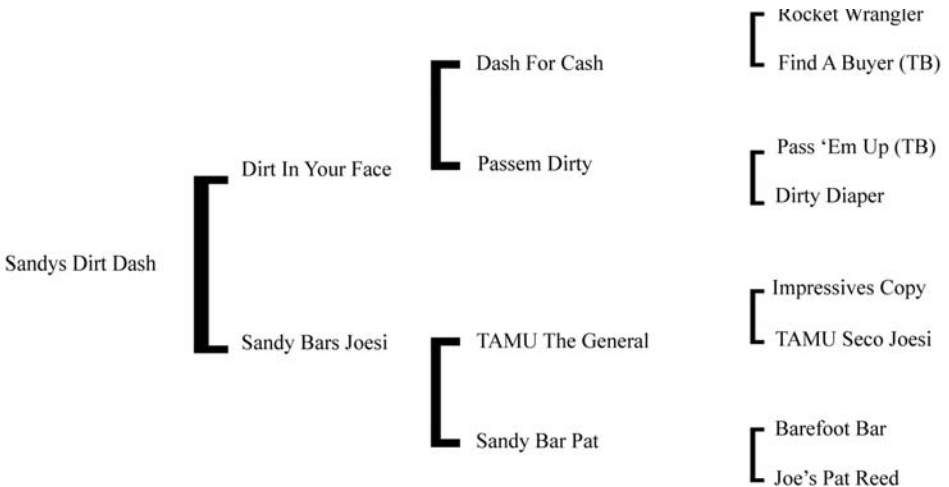

Notes: *This mare was broke to ride in race training and raced as a 3-yr old; produces big, athletic horses. Selling as a 3-in-1 package; filly by TAMU Peppy Rey Jay and mare is bred back to TAMU Peppy Rey Jay.*

Last breeding day: 3/16/2013

Sire: by DASH FOR CASH (2-time Champion of Champions

Invitational; 2-time All-time Leading Sire; AQHA Hall of Fame; 1976 & 1977 World Champion Quarter Running Horse. /

Dam: grandsire is IMPRESSIVES COPY (AQHA point earner in Halter).

Lot 8

Consignment from Texas A&M University

TAMU Smart Lil Nu Bar

AQHA# 5296724 • 2010 Sorrel Gelding

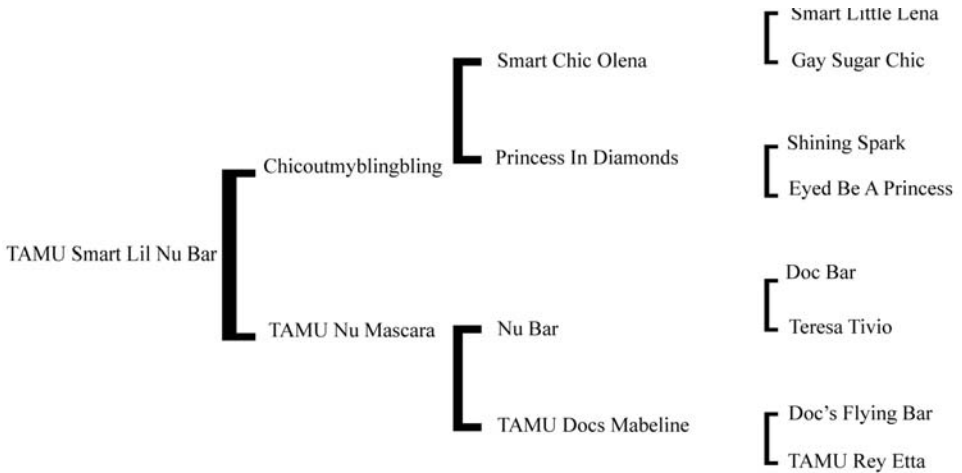

Notes: *Another reining prospect; pretty mover and a pretty individual.*

Sire: CHICOUTMYBLINGBLING (reference sire); grandsire SMART CHIC OLENA (AQHA World Senior Cutting & Reining Open Champion; Hall of Fame; NRHA World Champion, Reserve World Champion NRHA Open).

Dam: by NU BAR (AQHA Reserve World Champion cutting, ROM performance, NCHA Bronze Award, Top Ten World Show. NCHA earnings \$16,539. Sire of NCHA/NRHA money earners; Top Stallion Ranked By All Time Offspring Cutting earnings and All Time Offspring Lifetime Average Cutting earnings. LTE \$895,493. Sire of Superiors in Halter & Performance)

Lot 9

Consignment from Texas A&M University

TAMU Watch Me Shine

AQHA# 5296729 • 2010 Bay Gelding

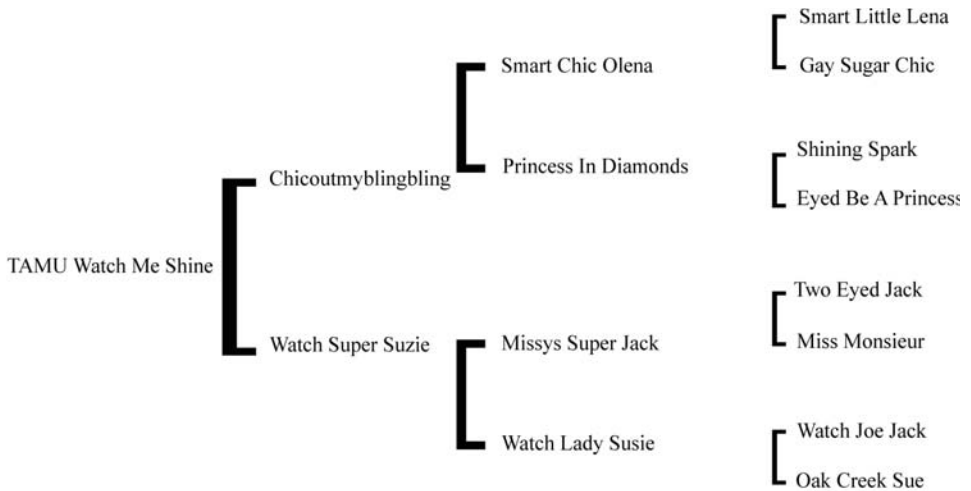

Notes: *Talk about a ranch horse and looks to go with it! Foundation bred on the bottom side.*

Sire: CHICOUTMYBLINGBLING (reference sire) Superior bloodlines; by SMART CHIC OLENA (AQHA World Senior Cutting & Reining Champion) and out of PRINCESS IN DIAMONDS, NRHA (producer of 3 NRHA Open Futurity Finalists, including Whizkey N Diamonds and Cromed Out Mercedes).

Dam: bloodlines back to TWO EYED JACK (AQHA Champion, Superior Performance stallion) & WATCH JOE JACK (AQHA Champion, Superior Western Pleasure).

Lot 10

Consignment from Texas A&M University

TAMU ShininEnterpriz

AQHA# 5309394 • 2010 Bay Mare

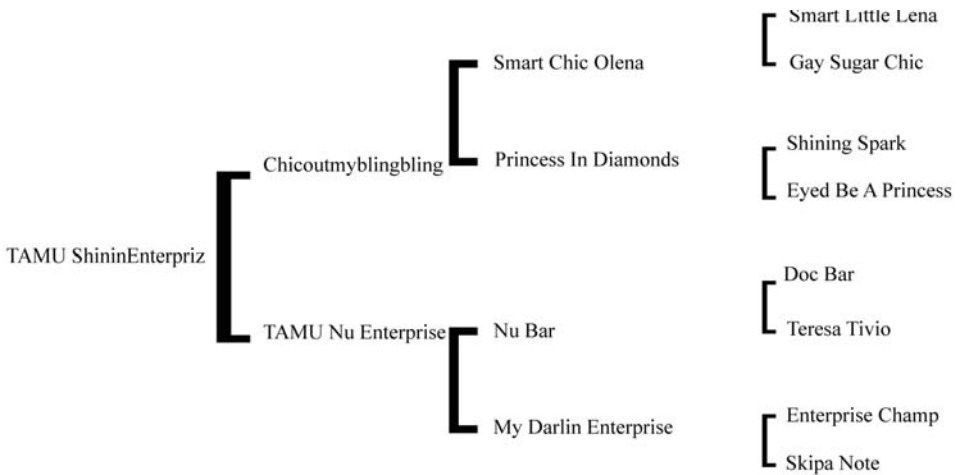

Notes: *Pretty individual; very well bred. A great contribution to your herd! Enrolled in the National Reining Breeders Classic.*

Sire: CHICOUTMYBLINGBLING by SMART CHIC OLENA, (Won both Non-Pro & Ltd. Open NRHA Derby; AQHA Reserve World Champion; 4x AQHA Reserve World Champion; 2xUSET Open Qualifier Champion. LTE \$100,000; Offspring earnings \$560,000).

Dam: by NU BAR (AQHA Reserve World Champion cutting, ROM performance, NCHA Bronze Award, Top Ten World Show. NCHA earnings \$16,539. Sire of NCHA/NRHA money earners; Top Stallion Ranked By All Time Offspring Cutting earnings and All Time Offspring Lifetime Average Cutting earnings. LTE \$895,493. Sire of Superiors in Halter & Performance)

Lot 11

Consignment from Texas A&M University

TAMU Nu Troubadour

AQHA# 5364530 • Bay Gelding



Notes: *Big, stout horse; bred to be used for reining or cutting. Started under saddle 7 weeks ago. Enrolled in the National Reining Breeders Classic.*

Sire: CHICOUTMYBLINGBLING (reference sire) by SMART CHIC OLENA (AQHA World Senior Cutting & Reining Champion) and out of PRINCESS IN DIAMONDS, NRHA (producer of 3 NRHA Open Futurity Finalists, including Whizkey N Diamonds and Cromed Out Mercedes).

Dam: by NU BAR (AQHA Reserve World Champion cutting, ROM performance; Sire of NCHA/NRHA money earners; Top Stallion Ranked By All Time Offspring Cutting earnings and All Time Offspring Lifetime Average Cutting earnings. LTE \$895,493. Sire of Superiors in Halter & Performance).

Lot 12

Consigned by Jay & Krissy Schroeder

Slick Slidin Jag

AQHA# Pending • 2011 Black Gelding

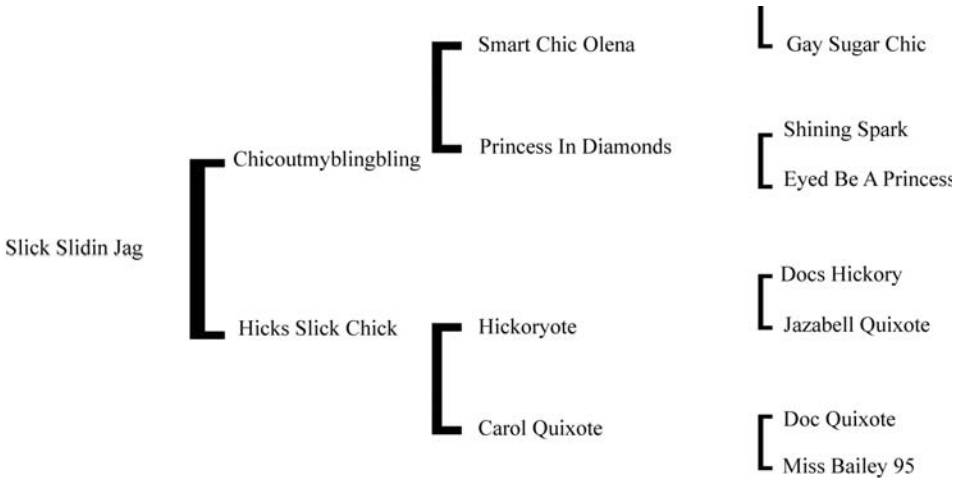

Notes: *Great pedigree and color to go with it! Easy going, great mind, and eager to please. Great potential youth horse. Started under saddle 7 weeks ago.*

Sire: CHICOUTMYBLINGBLING, by SMART CHIC OLENA (AQHA World Senior Cutting & Reining Champion) and out of PRINCESS IN DIAMONDS, NRHA (producer of 3 NRHA Open Futurity Finalists, including Whizkey N Diamonds and Cromed Out Mercedes).

Dam: by HICKORYOTE, (NCHA \$107,450 COA; Million Dollar Sire; Total LTE \$114,500; placed 3rd 1987 NCHA Non-Pro Futurity; offspring earnings \$1,250,000; World Champion Futurity finalist producer; Sire of AQHA World Champion, NCHA Derby Finalist; Equi-Stat All-time Leading Sire list), out of dam by DOC QUIXOTE (NCHA \$3,728.96; NCHA COA; 1973 NCHA Cutting Futurity Non-Pro Champion; NCHA Hall of Fame Sire).

Lot 13



Consignment from Texas A&M University

Bobby Sox Baroness

AQHA# 4572213 • 2003 Sorrel Mare

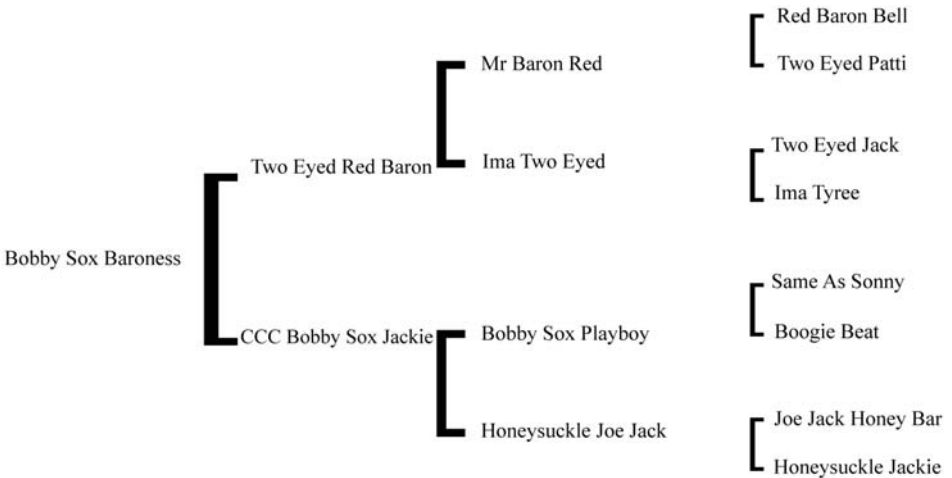

Notes: *She is a producer of foals with size and athleticism! This mare sells in foal to TAMU Peppy Rey Jay; last breeding date: 4/8/2013.*

Sire: TWO EYED RED BARON (reference sire); 91 % Foundation bred; AQHA Performance Champion; 547 AQHA Open Points.

Dam: grandsire is BOBBY SOX PLAYBOY (reference sire); AQHA Performance Champion; 745 AQHA points; AQHA Open Superiors in Heading, Heeling, and Calf Roping.

Lot 14

Consignment from Texas A&M University

TAMU Jack Be Nimble

AQHA# 5365694 • 2011 Sorrel Gelding

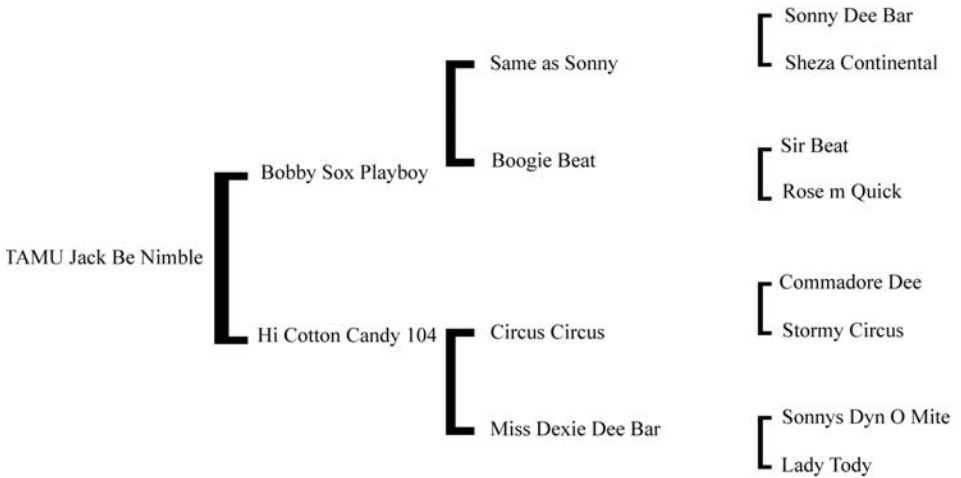

Notes: *Ranch horse / stock horse / roping prospect... with a flashy look to go with it! His sire has Open Superiors in Heading, Heeling, and Calf roping. Started under saddle 7 weeks ago.*

Sire: BOBBY SOX PLAYBOY (reference sire); AQHA Performance Champion; 745 AQHA points in heading, heeling, calf roping, working cow horse, reining, and halter.

Dam: by CIRCUS CIRCUS (goes back to Sonny Dee Bar – Hall of Fame stallion; Superior Halter).

Lot 15

Consignment from Texas A&M University

CDs Nu Moves

AQHA# 5080501 • 2008 Gray Mare

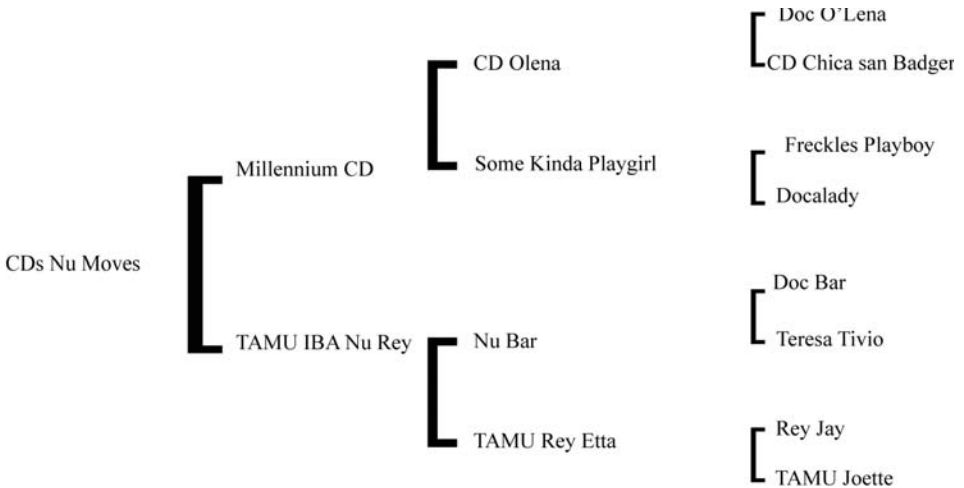

Notes: Look at “Tink’s” bloodlines! Grandsire is CD Olena, sire of multiple champions in the cutting pen; out of a Nu Bar mare.

Sire: MILLENNIUM CD (reference sire); By NCHA Futurity Champion, and half-brother to Some Kinda Memories (NCHA \$378,546) .

Dam: by NU BAR, AQHA Reserve World Champion cutting, ROM performance, NCHA Bronze Award, Top Ten World Show, sire of NCHA/ NRHA money earners, LTE \$895,493; goes back to REY JAY (AQHA Championship, AQHA Superior in cutting & NCHA Bronze Award).

Lot 16

Consignment from Texas A&M University

TAMU A Jagin Deelux

AQHA# 5364528 • 2011 Sorrel Gelding

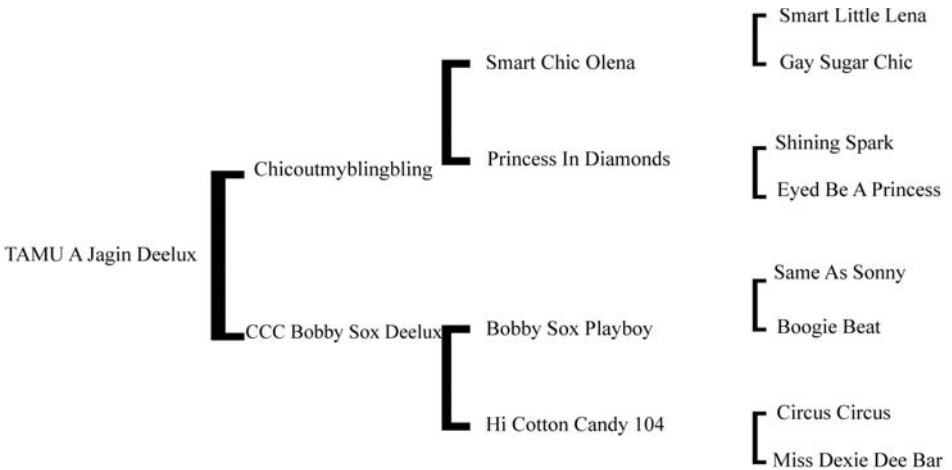

Notes: *Nice bred colt; bred to be a ranch/stock horse. Good mover. Started under saddle 7 weeks ago.*

Sire: CHICOUTMYBLINGBLING, by SMART CHIC OLENA (AQHA World Senior Cutting & Reining Champion) and out of PRINCESS IN DIAMONDS, NRHA (producer of 3 NRHA Open Futurity Finalists, including Whizkey N Diamonds and Cromed Out Mercedes).

Dam: by BOBBY SOX PLAYBOY (reference sire); AQHA Performance Champion; 745 AQHA points; AQHA Open Superiors in Heading, Heeling, and Calf Roping.

Lot 17



Consignment from Texas A&M University

TAMU Dixie Darlin

AQHA# 5367677 • 2011 Sorrel Mare

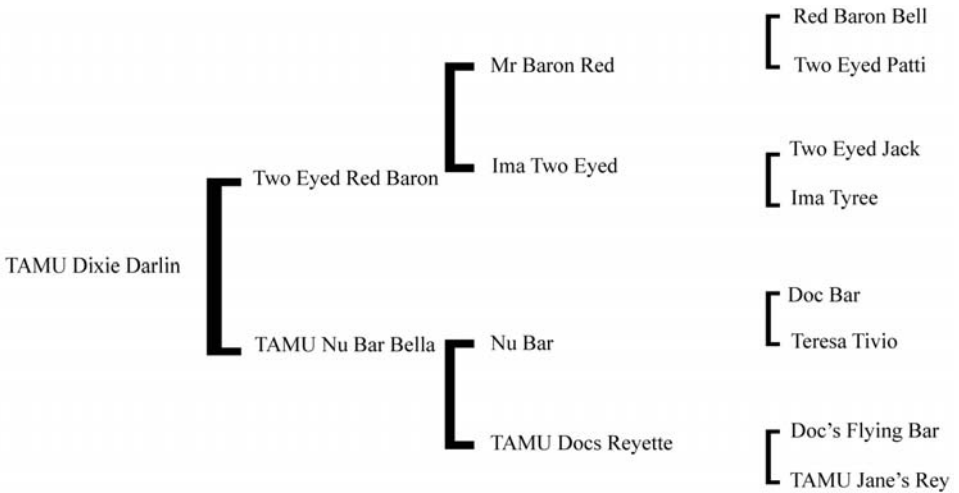

Notes: *Very pretty filly; lots of color and refined. Started under saddle 7 weeks ago.*

Sire: TWO EYED RED BARON (reference sire); 91 % Foundation bred; AQHA Performance Champion; 547 AQHA Open Points

Dam: NU BAR (AQHA Reserve World Champion cutting, ROM performance, NCHA Bronze Award, Top Ten World Show. NCHA earnings \$16,539. Sire of NCHA/NRHA money earners; Top Stallion Ranked By All Time Offspring Cutting earnings and All Time Offspring Lifetime Average Cutting earnings. LTE \$895,493. Sire of Superiors in Halter & Performance); goes back to DOC'S FLYING BAR (NCHA money earner; sire of FEELAFIELA, NCHA \$60,376; sire of NCHA money earners / ROM).

Lot 18

Consignment from Texas A&M University

TAMU A Nu Bar Baron

AQHA# 5373814 • 2011 Sorrel Gelding

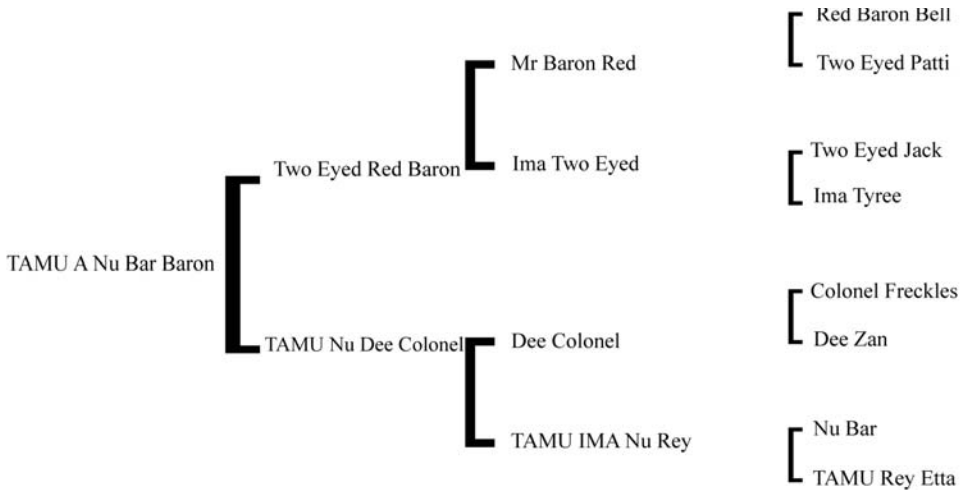

Notes: *Ropers....be sure to take a look at this horse! Team-roping prospect deluxe. Big, stout, and bloodlines to prove it.*

Sire: TWO EYED RED BARON (reference sire); 91 % Foundation bred and 44% Two Eyed Jack, the All-time Leading Sire of AQHA Champions; Superiors in Heading, Heeling, and Calf-roping, and ROM Halter.

Dam: granddaughter to COLONEL FRECKLES (sire of AQHA World Champion, 2 AQHA Reserve World Champions, 9 AQHA Superior Performers, 66 AQHA Arena ROM; sire of NRHA Money Earners \$123,092, and Leading Maternal Grandsire NRHA Money Earners; NCHA Money Earners \$3,721,256; Leading Sire and Maternal Grandsire NCHA & NRCHA Money Earners).

Lot 19

Consignment from Texas A&M University

TAMU Jazzy LilClancy

AQHA# 5364529 • 2011 Sorrel Gelding

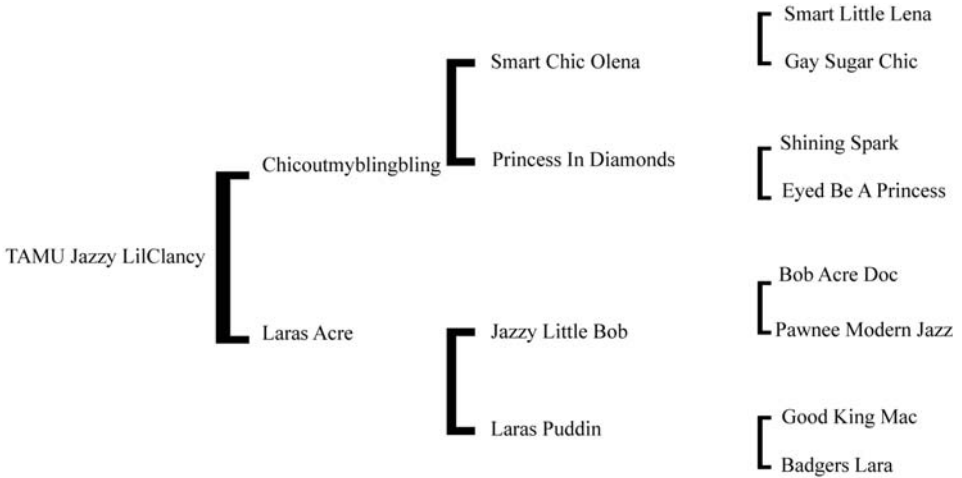

Notes: *Tremendous athlete. Bred to be a reiner or cutter. Good mover; good mind. Full brother to Lot #1. Enrolled into the National Reining Breeders Classic.*

Sire: CHICOUTMYBLINGLBING (reference sire). By the great SMART CHIC OLENA (AQHA World Senior Cutting & Reining Champion) and out of PRINCESS IN DIAMONDS, NRHA (producer of 3 NRHA Open Futurity Finalists, including Whizkey N Diamonds and Cromed Out Mercedes).

Dam: By JAZZY LITTLE BOB (producer of 18 performers; sire of Jazz It Up Honey, \$18,862 & finalist in the Memphis 4-yr-old Futurity, plus 3 other money earners over \$10,000); Grandsire – BOB ACRE DOC (2 time World Champion Sire of offspring earnings in excess of \$6.9 million).

SOUTH TEXAS TACK

BRENHAM, TEXAS



"The Ultimate Horseman's Destination"

Boots, Jeans, Shirts, Belts, Hats, Saddles and Tack

Custom Saddles and Tack

www.southtexastack.com

4765 Hwy. 290 East, Brenham, TX 77833

(877) STX-TACK

Find us on Facebook!





*Providing Complete Health
Care For Your Horses*

Walt Disney

Quincy Cabell Allen & Composer's Chick

SPECIALIZING IN SURGERY AND SPORTS MEDICINE

CLIFF HONNAS, DVM, DACVS
DIPLOMATE OF AMERICAN COLLEGE OF VETERINARY SURGEONS

CAMERON STOUTD, DVM

CANAAN WHITFIELD-CARGILE, DVM, DACVS



13688 SOUTH STATE HIGHWAY 6 (CORNER OF OSR AND HIGHWAY 6), BRYAN, TEXAS 77807
979-778-2529 WWW.TEXASEQUINEHOSPITAL.COM

2008

All Types of Structural Material - Metal Building Components

New & Used Pipe - Steel - Tubing

PIONEER



Jeff Smith

9401 East State Hwy. 21 Bryan, Texas 77808

(979)589-2333 Fax (979)589-2455 (866)959-2333

www.pioneerboys.com

MADISONVILLE KAWASAKI

304 S. May • MADISONVILLE, TX 77864

KAWASAKI • HUSQVARNA

Billy Terry

General Manager

(936) 348-9190

(866) 617-6853

Fax (936) 348-5795

'One Customer Tells Another'



EZ HORSESHOEING LLC



Patrick Zoller
Farrier

College Station, TX
979-436-7897

zollerpatrick@yahoo.com

P.O. Box 397
Madisonville, Texas 77864



Dave Golden Quarter Horses

*Training * Showing * Clinics*

(936)348-2072

Website: davegoldenquarterhorses.com

**Quality Handmade Spurs,
Jewelry, Buckles and More**



Scot Sommerlatte Originals

www.ss-originals.com · 979-203-7745

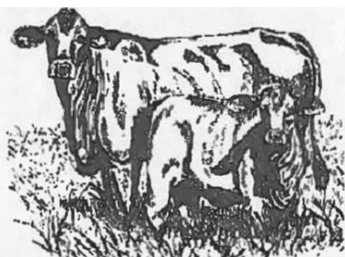
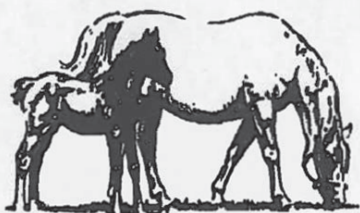

Birdsong Farms

**Cutting, Reining and Ranch Horses
Reproductive Services**

Stephen & Martha Vogelsang

Hearne, Texas

979.229.3439

stephen.vogelsang@yahoo.com



Whether you have a barn full of horses,
or just enjoy spending your time with one,
you want the best feed, health care, tack,
and grooming supplies your money can buy.

We've got it. All of it.

PRODUCERS

Texas Avenue, 1 block North of 21 in Bryan,
979.778.600 or e-mail at producers@producerscooperative.com

Everything Ag... Everything Equine!